



## **User & Technical Manual**

### **A2A Heat Exchangers**

Compact, Slim, Deep & Tall Series

*Rev 1.2*



## **CAUTION**

**Read Manual Before Installation.  
For Questions, Please Call ISC at  
(800)-836-7472**

***To Be Professionally Installed Only***



**Title:** A2A, Air to Air Heat Exchangers Technical Manual

**Department:** Engineering

**Objective:** To provide important information for maintenance, diagnostics and advance operations of the ISC A2A Compact, Slim, Deep, & Tall Series Heat Exchangers.

**Revision History:**

Rev	Date	Owner	Description of Changes
1.1	12-07-10	G. Gonzalez	New Format Initial Release
1.2	11-16-11	G. Gonzalez	Update Electrical Schematic

**Statement of Confidentiality**

The Manual and other materials contain proprietary information, comprising ISC Inc.'s trade secrets. Please maintain the confidentiality of all proprietary information during and after the term of the use agreement. Also, please refrain from using this proprietary information in any other manner, including in any other business, without ISC Inc.'s written approval.

ISC Inc. reserves the right to revise and otherwise modify the Manual to reflect changes in the requirements, standards, and operating recommendations. The Manual is the sole property of ISC Inc. It must be returned upon the expiration or the termination of the term of use agreement.

By accepting the Manual you have read and understand the Statement of Confidentiality and will abide by its terms and conditions.



## TABLE OF CONTENTS

Overview	4
Inspecting the Equipment	4
Unpacking the Heat Exchanger	4
Moving the Heat Exchanger	5
Unit Label	5
Operation	6
Preliminary Testing	6
Mounting the Heat Exchanger	7
Unit Specifications	8
Options	12
Preventative Maintenance	12
Field Serviceable Parts	13
Safety Information	13
Troubleshooting Guide	14
Physical Dimensions	15
Electrical Schematic	17
Warranty Information	18
Return Material Authorization (RMA) Procedure	19

4421 Tradition Trail • Plano, Texas 75093 • 972-964-2700 • 800-836-7472

URL: [www.iscenclosurecooling.com](http://www.iscenclosurecooling.com) • Email: [iscinfo@iscsales.com](mailto:iscinfo@iscsales.com)



## Overview

Thank you for your purchase of the ISC Heat Exchanger. Our heat exchanger equipment is carefully designed to cool the air in electronic component enclosures. ISC has designed heat exchangers for all types of electronic equipment enclosures providing capacity from 11 Watts/°C to 71.6 Watts/°C.

This manual will guide you through the installation, maintenance, diagnostics and advance operations of the Compact, Slim, Deep and Tall Series Heat Exchangers. This manual contains important information for the end-user who installs, maintains and/or operates the Heat Exchangers.

### Technical Support

By Phone: 972-964-2700 / 800-836-7472

*(Monday – Friday, 7:30 am – 5:00 pm Central Time)*

By Email: [iscinfo@iscsales.com](mailto:iscinfo@iscsales.com)

Our goal is to have continuous improvement for both our equipment and our documentation. We rely upon and appreciate your feedback to help us achieve our goal. Our technical support team is glad to work with you if you require additional technical information not provided in this manual.

## Inspecting the Equipment

ISC Air to Air Heat Exchanger equipment is designed, manufactured and packed to prevent damage from normal handling, shock and vibration during shipment. It is necessary to inspect your equipment upon receipt to insure that there is no visual or hidden damage.

All physical damage to packing or signs of damage to the equipment must be noted on the freight bill of lading. Packages must be opened after receipt and inspected for any visual or concealed damage to the equipment and to verify proper count and order fulfillment. Delivery of without the pallet, other freight on top, damaged or wet should be refused.

## Unpacking the Heat Exchanger

If the unit is to be transported after initial unpacking, place air conditioner back in original packing to prevent damage.

For shipment by UPS or freight carrier, repack as received.

**Note:** Shipping without proper packing material will void the warranty.



## Moving the Heat Exchanger

Read this section completely before running or installing your ISC heat exchanger equipment.

**Note:** You will need to perform a Preliminary Test before mounting the heat exchanger. Refer to the Preliminary Test section in this manual for instructions on how to run this test. You will also need to prepare the enclosure that is to be cooled for mounting in accordance with this manual and the template supplied.

**Note:** ISC heat exchanger equipment must be **mounted vertically** with a **minimum of 5"** air space for condenser air return and supply. If necessary, equipment may be mounted at up to a 5 degree vertical angle.

If heat exchanger is to be shipped or transported at any time; pack in original packaging to prevent damage. Heat Exchangers must be kept upright at all times. Heat Exchangers are not designed to be shipped attached to an equipment enclosure. Heat Exchangers shipped which have internal damage due to shipping while attached to enclosures are warranty voided.

## Unit Label

Each heat exchanger has a unit label, be sure to record the data from the label to the template below and keep this information in a safe place for warranty and ordering parts. To prevent damage to equipment, electrical panel and wiring, and to prevent personal injury, assure that the power source is compatible with the equipment before operating.

 <b>ISC, Inc.</b> 4421 Tradition Trail Plano, Texas 75093 USA 972.964.2700 800.836.7472 www.iscenclosurecooling.com	<b>Warranty Template</b> Keep this information in a safe place for warranty and ordering parts.		
	Volts <input type="text"/>	Amps <input type="text"/>	Phase <input type="text"/>
Refrigerant <input type="text"/>	<input type="text"/>	<input type="text"/>	Ounces
Design Pressure:			
Low Side <input type="text"/>	psi	High Side <input type="text"/>	psi
NEMA Type <input type="text"/>			
S/N <input type="text"/>			
MODEL No. <input type="text"/>			
NOTES:			

4421 Tradition Trail • Plano, Texas 75093 • 972-964-2700 • 800-836-7472

URL: [www.iscenclosurecooling.com](http://www.iscenclosurecooling.com) • Email: [iscinfo@iscsales.com](mailto:iscinfo@iscsales.com)



## Operation

ISC Air to Air Heat Exchanger will lower the temperature inside an enclosure to ensure its proper operational temperature. Our heat exchangers, when sized properly, will provide cooling to a temperature slightly higher than the ambient temperature.

ISC Air to Air Heat Exchangers operate as a “closed loop” system with no exposure or introduction of outside air. This insures that the enclosure is separated from and is not contaminated with ambient air, dirt, chemicals, dust, moisture or foreign matter so that sensitive enclosure components are protected and are kept at your required operational temperature.

## Preliminary Testing

Before mounting the heat exchanger to the enclosure, test for proper operation. Follow the steps below prior to installation.



### WARNINGS

Check the unit label to assure the electric power available to the air conditioner is the proper voltage and phase. Check the electric power source for proper ground wire and neutral wire installation per 2008 NEC. Assure that the electric power is protected by a circuit protection device; refer to the Unit Specification section in this manual for proper circuit protection sizing.

- Plug the unit’s power cord into your source and toggle power switch\* to start the fans.
- Turn the unit off if the equipment makes any unexpected or hard mechanical noises or vibrations and refer to the troubleshooting guide in this manual.
- When you are satisfied that the unit is operating properly, turn unit off, disconnect the power and mount the unit on the enclosure in accordance with the Mounting the Heat Exchanger section in this manual.

\* Hazardous Location models do not have a power switch.

4421 Tradition Trail • Plano, Texas 75093 • 972-964-2700 • 800-836-7472

URL: [www.iscenclosurecooling.com](http://www.iscenclosurecooling.com) • Email: [iscinfo@iscsales.com](mailto:iscinfo@iscsales.com)



## Mounting the Heat Exchanger

Using the template supplied, determine where the heat exchanger is to be mounted and assure that all required cuts and holes will not interfere with or damage the enclosure or its contents. Assure that there is a 5" clearance between walls / obstructions and the heat exchanger for the condenser supply air and return air flow so that it is not restricted. Restricted condenser air flow will affect the heat exchanger's performance. Mount the heat exchanger high on the enclosure in order to cool the hot air in the top of the enclosure. Position the unit where the cold air can circulate across the width of the enclosure to cool it all the way across.

Once proper mounting placement is determined, turn the enclosure equipment off, if possible. Drill and cut the holes as indicated on the mounting template. Install insulation gasket as required to insure an air tight closed loop seal. Be cautious not to let any cutting debris fall into the enclosure. Attach the hanging bolts as indicated on the template to hold the unit onto the enclosure and then use the mounting screws that are provided.

Hang the heat exchanger on the hanging bolts and from inside the enclosure use the fasteners supplied to attach the heat exchanger to the enclosure. Insure that these fasteners are tight in order to prevent the unit from falling off the enclosure. These fasteners should be checked periodically to insure that they have not become loose due to vibration.

Ensure that the power supplied is compatible with the heat exchanger's power requirements. Properly attach the unit's power cord to a circuit that meets the equipment requirements and provide a circuit protection device based on the Unit Specifications section of this manual.

After mounting the heat exchanger, replace/close the enclosure door and start heat exchanger; test for air leaks to assure a proper closed air loop seal and run test the unit to assure proper operation after mounting. If any cold air leaks are found, check for proper mounting and apply silicone-free Lexel seal if leaks persist.



### **CAUTION**

If mounting the heat exchanger to the enclosure door, confirm with the enclosure manufacturer that the door's hinges will support the heat exchanger's added weight (see equipment specifications). Insure that when the door is fully open that the enclosure will not topple over due to the off-center load.



## Unit Specifications

The following table provides electrical specifications for the ISC A2A Compact, Slim, Deep, & Tall Series Heat Exchangers

### A2AC – Compact Series

Standard Maximum Ambient: 160°F

Unit Weight: 20lbs

Mounting Dimensions (H x W x D): 16.5" x 11" x 3.5"

Model	Operating Voltage Range (Volts)	Inrush Current (Start Up Current) (Amps)	Loading Current (Running Current) (Amps)	SCCR (Short Circuit Current Rating) (Amps)	Recommended Circuit Protection Device Rating (Amps)	VA Rating (Watts)	Refrigerant Type (amount in oz)	Watt/°C	Free Air Flow (CFM)
A2AC040120	110-120	1.92	0.35	*2	1.5 Amp *	42	CH3OH (0.41)	11	131
A2AC040230	220-240	1.65	0.18	*2	1 Amp *	42	CH3OH (0.41)	11	131
A2AC040D24	21.6-26.4	3.90	0.80	*2	2.5 Amp *	20	CH3OH (0.41)	11	127
A2AC040D48	43.2-52.8	2.00	0.40	*2	1.25 Amp *	20	CH3OH (0.41)	11	127
A2AC080120	110-120	1.92	0.35	*2	1.5 Amp *	42	CH3OH (0.41)	22	131
A2AC080230	220-240	1.65	0.18	*2	1 Amp *	42	CH3OH (0.41)	22	131
A2AC080D24	21.6-26.4	3.90	0.80	*2	2.5 Amp *	20	CH3OH (0.41)	22	127
A2AC080D48	43.2-52.8	2.00	0.40	*2	1.25 Amp *	20	CH3OH (0.41)	22	127

\* Fast Acting Fuses with the following electrical characteristics are recommended. Do not use Extremely Fast Acting Fuse.

% of Ampere Rating	Opening Time
100 %	None
135 %	60min Maximum
200 %	120sec Maximum

\*2 SCCR rating is based on the SCCR rating for the circuit protection device installed in the panel / enclosure per UL50 & UL508a to protect the AC unit. Typically 10KA for Fast Acting Fuses.

4421 Tradition Trail • Plano, Texas 75093 • 972-964-2700 • 800-836-7472

URL: [www.iscenclosurecooling.com](http://www.iscenclosurecooling.com) • Email: [iscinfo@iscsales.com](mailto:iscinfo@iscsales.com)



**A2AS – Slim Series**

Standard Maximum Ambient: 160°F

Unit Weight: 28lbs

Mounting Dimensions (H x W x D): 21.0" x 5.6" x 11.0"

<b>Model</b>	<b>Operating Voltage Range</b> <b>(Volts)</b>	<b>Inrush Current</b> <i>(Start Up Current)</i> <b>(Amps)</b>	<b>Loading Current</b> <i>(Running Current)</i> <b>(Amps)</b>	<b>SCCR</b> <i>(Short Circuit Current Rating)</i> <b>(Amps)</b>	<b>Recommended Circuit Protection Device Rating</b> <b>(Amps)</b>	<b>VA Rating</b> <b>(Watts)</b>	<b>Refrigerant Type</b>  (amount in oz)	<b>Watt/°C</b>	<b>Free Air Flow</b>  <b>(CFM)</b>
A2AS040120	110-120	1.92	0.35	*2	1.5 Amp *	42	CH3OH (0.81)	11	131
A2AS040230	220-240	1.65	0.18	*2	1 Amp *	42	CH3OH (0.81)	11	131
A2AS040D24	21.6-26.4	3.90	0.80	*2	2.5 Amp *	20	CH3OH (0.81)	11	127
A2AS040D48	43.2-52.8	2.00	0.40	*2	1.25 Amp *	20	CH3OH (0.81)	11	127
A2AS080120	110-120	1.92	0.35	*2	1.5 Amp *	42	CH3OH (0.81)	22	131
A2AS080230	220-240	1.65	0.18	*2	1 Amp *	42	CH3OH (0.81)	22	131
A2AS080D24	21.6-26.4	3.90	0.80	*2	2.5 Amp *	20	CH3OH (0.81)	22	127
A2AS080D48	43.2-52.8	2.00	0.40	*2	1.25 Amp *	20	CH3OH (0.81)	22	127
A2AS120120	110-120	1.92	0.35	*2	1.5 Amp *	42	CH3OH (0.81)	33	131
A2AS120230	220-240	1.65	0.18	*2	1 Amp *	42	CH3OH (0.81)	33	131
A2AS120D24	21.6-26.4	3.90	0.80	*2	2.5 Amp *	20	CH3OH (0.81)	33	127
A2AS120D48	43.2-52.8	2.00	0.40	*2	1.25 Amp *	20	CH3OH (0.81)	33	127
A2AS160120	110-120	1.92	0.35	*2	1.5 Amp *	42	CH3OH (0.81)	44	131
A2AS160230	220-240	1.65	0.18	*2	1 Amp *	42	CH3OH (0.81)	44	131
A2AS160D24	21.6-26.4	3.90	0.80	*2	2.5 Amp *	20	CH3OH (0.81)	44	127
A2AS160D48	43.2-52.8	2.00	0.40	*2	1.25 Amp *	20	CH3OH (0.81)	44	127

4421 Tradition Trail • Plano, Texas 75093 • 972-964-2700 • 800-836-7472

URL: [www.iscenclosurecooling.com](http://www.iscenclosurecooling.com) • Email: [iscinfo@iscsales.com](mailto:iscinfo@iscsales.com)



**A2AD – Deep Series**

Standard Maximum Ambient: 160°F

Unit Weight: 24lbs

Mounting Dimensions (H x W x D): 16.5" x 11" x 5.5"

<b>Model</b>	<b>Operating Voltage Range</b>  (Volts)	<b>Inrush Current</b> (Start Up Current)  (Amps)	<b>Loading Current</b> (Running Current)  (Amps)	<b>SCCR</b> (Short Circuit Current Rating)  (Amps)	<b>Recommended Circuit Protection Device Rating</b>  (Amps)	<b>VA Rating</b>  (Watts)	<b>Refrigerant Type</b>  (amount in oz)	<b>Watt/°C</b>	<b>Free Air Flow</b>  (CFM)
A2AD120120	110-120	1.92	0.35	*2	1.5 Amp *	42	CH3OH (0.81)	33	131
A2AD120230	220-240	1.65	0.18	*2	1 Amp *	42	CH3OH (0.81)	33	131
A2AD120D24	21.6-26.4	3.90	0.80	*2	2.5 Amp *	20	CH3OH (0.81)	33	127
A2AD120D48	43.2-52.8	2.00	0.40	*2	1.25 Amp *	20	CH3OH (0.81)	33	127
A2AD160120	110-120	1.92	0.35	*2	1.5 Amp *	42	CH3OH (0.81)	44	131
A2AD160230	220-240	1.65	0.18	*2	1 Amp *	42	CH3OH (0.81)	44	131
A2AD160D24	21.6-26.4	3.90	0.80	*2	2.5 Amp *	20	CH3OH (0.81)	44	127
A2AD160D48	43.2-52.8	2.00	0.40	*2	1.25 Amp *	20	CH3OH (0.81)	44	127

\* Fast Acting Fuses with the following electrical characteristics are recommended. Do not use Extremely Fast Acting Fuse.

% of Ampere Rating	Opening Time
100 %	None
135 %	60min Maximum
200 %	120sec Maximum

\*2 SCCR rating is based on the SCCR rating for the circuit protection device installed in the panel / enclosure per UL50 & UL508a to protect the AC unit. Typically 10KA for Fast Acting Fuses.



**A2AT – Tall Series**

Standard Maximum Ambient: 160°F

Unit Weight: 36lbs

Mounting Dimensions (H x W x D): 29.0” x 13.88” x 5.5”

Model	Operating Voltage Range (Volts)	Inrush Current (Start Up Current) (Amps)	Loading Current (Running Current) (Amps)	SCCR (Short Circuit Current Rating) (Amps)	Recommended Circuit Protection Device Rating (Amps)	VA Rating (Watts)	Refrigerant Type (amount in oz)	Watt/°C	Free Air Flow (CFM)
A2AT200120	110-120	2.59	0.47	*2	2 Amp *	56	CH3OH (1.22)	55	211
A2AT200230	220-240	1.32	0.24	*2	1 Amp *	56	CH3OH (1.22)	55	211
A2AT200D24	21.6-26.4	9.7	1.94	*2	6 Amp *	47	CH3OH (1.22)	55	235
A2AT200D48	43.2-52.8	4.8	0.96	*2	3 Amp *	47	CH3OH (1.22)	55	235
A2AT260120	110-120	2.59	0.47	*2	2 Amp *	56	CH3OH (1.22)	72	211
A2AT260230	220-240	1.32	0.24	*2	1 Amp *	56	CH3OH (1.22)	72	211
A2AT260D24	21.6-26.4	9.7	1.94	*2	6 Amp *	47	CH3OH (1.22)	72	235
A2AT260D48	43.2-52.8	4.8	0.96	*2	3 Amp *	47	CH3OH (1.22)	72	235

\* Fast Acting Fuses with the following electrical characteristics are recommended. Do not use Extremely Fast Acting Fuse.

% of Ampere Rating	Opening Time
100 %	None
135 %	60min Maximum
200 %	120sec Maximum

\*2 SCCR rating is based on the SCCR rating for the circuit protection device installed in the panel / enclosure per UL50 & UL508a to protect the AC unit. Typically 10KA for Fast Acting Fuses.



## Options

The ISC A2A Compact, Slim, Deep, & Tall Series Heat Exchangers may be ordered with the following options. Review the list below for the specifications and functions of the option(s) that apply to your unit.

### Corrosive Protection Package

We offer a corrosive protection package consisting of electro-coated (e-coat) coils for superior corrosion protection.

### Custom Paint

Equipment may be ordered with any customer paint color.

### Explosion Proofing – Hazardous Location Unit

The ISC Hazardous Location units are in conformance with all requirements of UL and CUL for Class 1, Division 2, Groups A, B, C and D and will meet or exceed all the specifications for T6 areas.

## Preventative Maintenance

Air to Air Heat Exchangers may require regular cleaning of the condenser air inlet section depending on the environmental conditions. Restriction to the flow of air over the condenser section will degrade the performance of the equipment, reduce cooling and can damage the fans.

Refer to Field Serviceable Parts section in this manual for details on parts that can be changed to help increase the uninterrupted life of the heat exchanger.

### Condenser Air Inlet Cleaning

In the event of excess dust or particulates, clean the condenser air inlet section with a soft water spray or compressed air not to exceed 90 psi.

### Condenser and Evaporator Fans

ISC Air to Air Heat Exchangers use high efficiency, long life, sealed ball bearing fans engineered for optimum performance that require no maintenance. Fans are removable and employ plug-in electrical connections.



## Field Serviceable Parts

ISC carefully designs and selects components with the maximum life expectancy. Due to OEM manufacturing tolerances, poor unit maintenance or extreme operating conditions, components may fail before their maximum life expectancy. The table below lists parts that are serviceable in the field by an Air Conditioner Technician.

Part Description	ISC Part #
<b>Unit Fans</b>	<b>Quantity 2 Per Unit</b>
120 VAC Compact, Slim & Deep Series	41004-1-1
230 VAC Compact, Slim & Deep Series	41004-2-1
24 VDC Compact, Slim & Deep Series	41003-3-1
48 VDC Compact, Slim & Deep Series	41003-5-1
120 VAC Tall Series	41005-1-1
230 VAC Tall Series	41005-2-1
24 VDC Tall Series	41005-3-1
48 VDC Tall Series	41010-4-1

## Safety Information

Unit is carefully designed to restrict access to movable parts to minimize any potential injury. This heat exchanger has been tested by UL to meet the safety requirements of the UL1995 specification. When working with the ISC Air to Air Heat Exchanger always make sure shroud is installed. Verify proper voltage is applied to unit as specified in the UL label of the heat exchanger. In the event of a field service repair, power down unit using the power on/off switch and disconnect power from unit. It is always recommended to use a licensed Air Conditioner Technician for internal diagnostics and repairs issues.

Contact ISC technical support for further details on opening the unit and troubleshooting tips.



## Troubleshooting Guide

The following guide provides a flow chart to identify a problem, determine the root cause and identify the action needed to correct an issue.

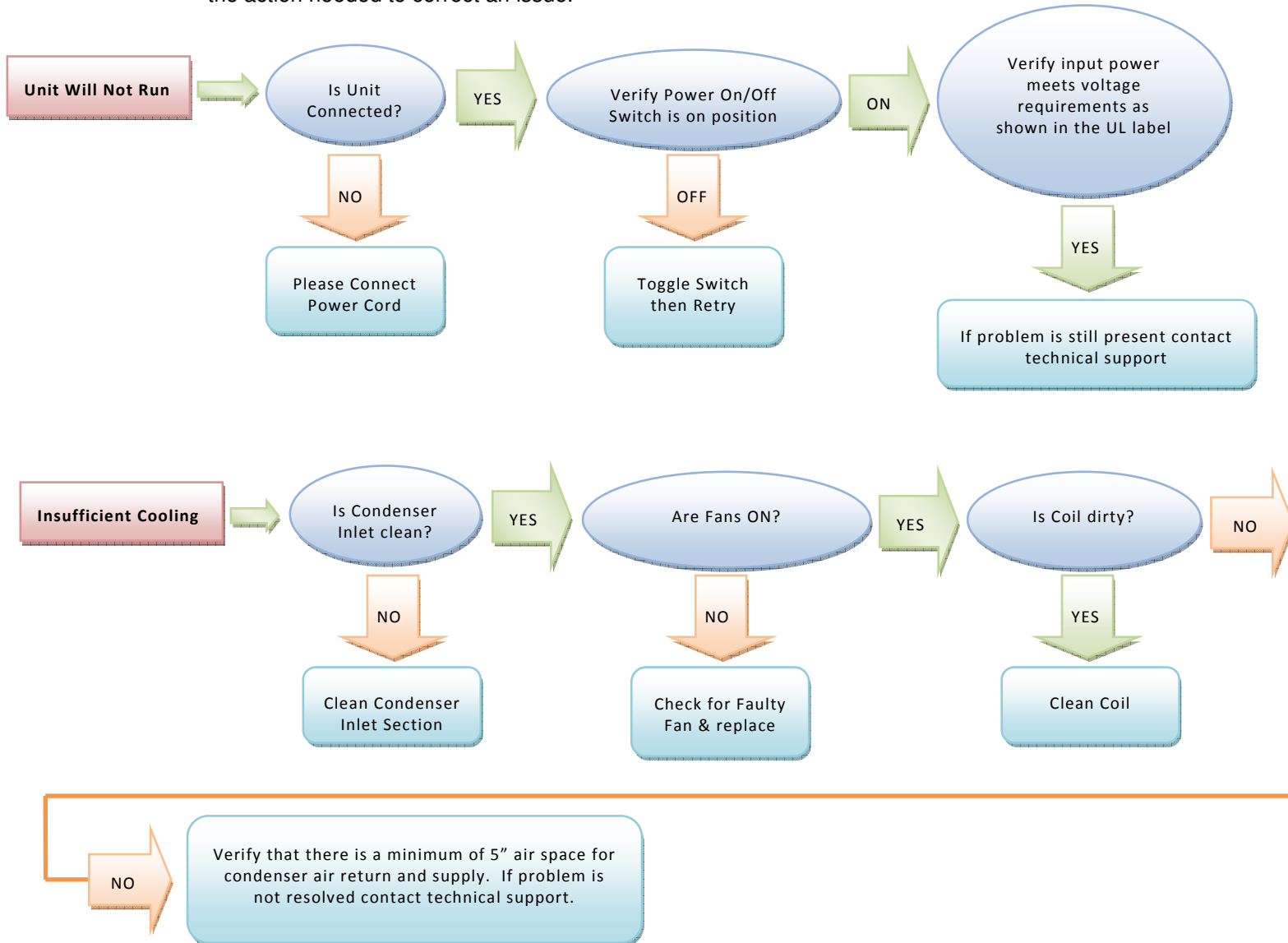



## Physical Dimensions

### Compact Series

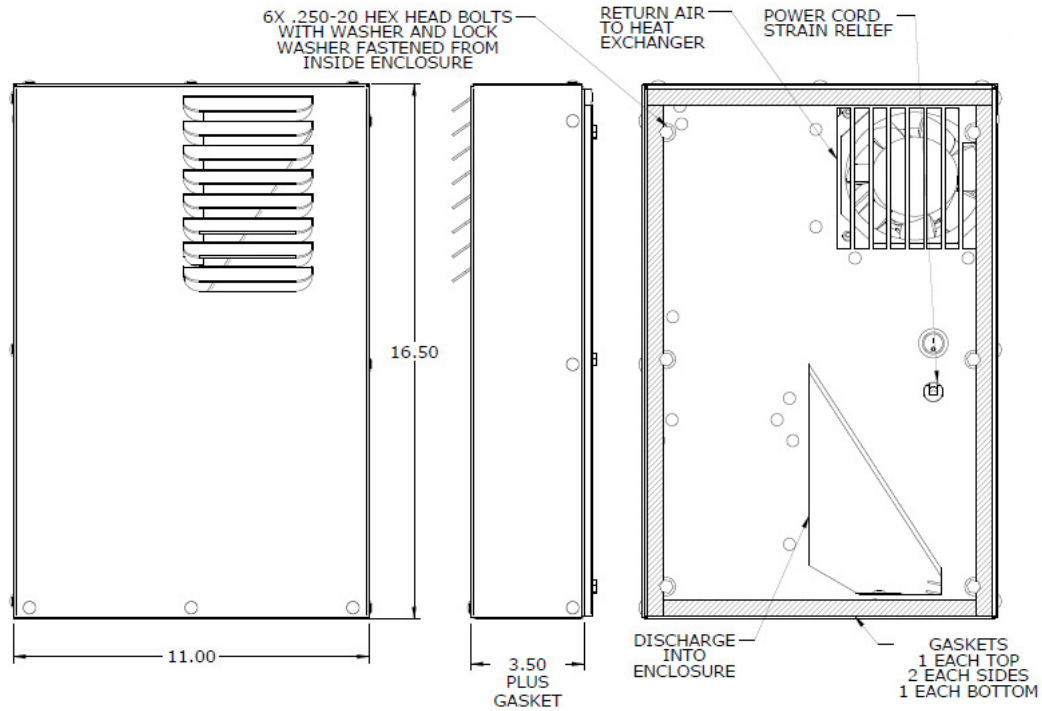

### Slim Series

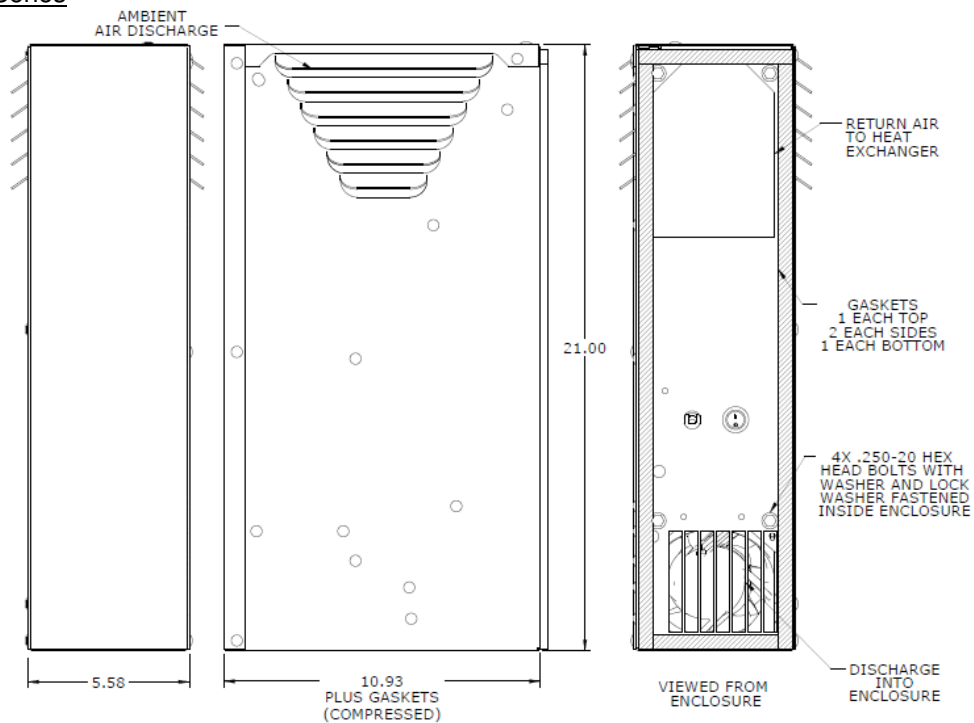

4421 Tradition Trail • Plano, Texas 75093 • 972-964-2700 • 800-836-7472

URL: [www.iscenclosurecooling.com](http://www.iscenclosurecooling.com) • Email: [iscinfo@iscsales.com](mailto:iscinfo@iscsales.com)



**Deep Series**

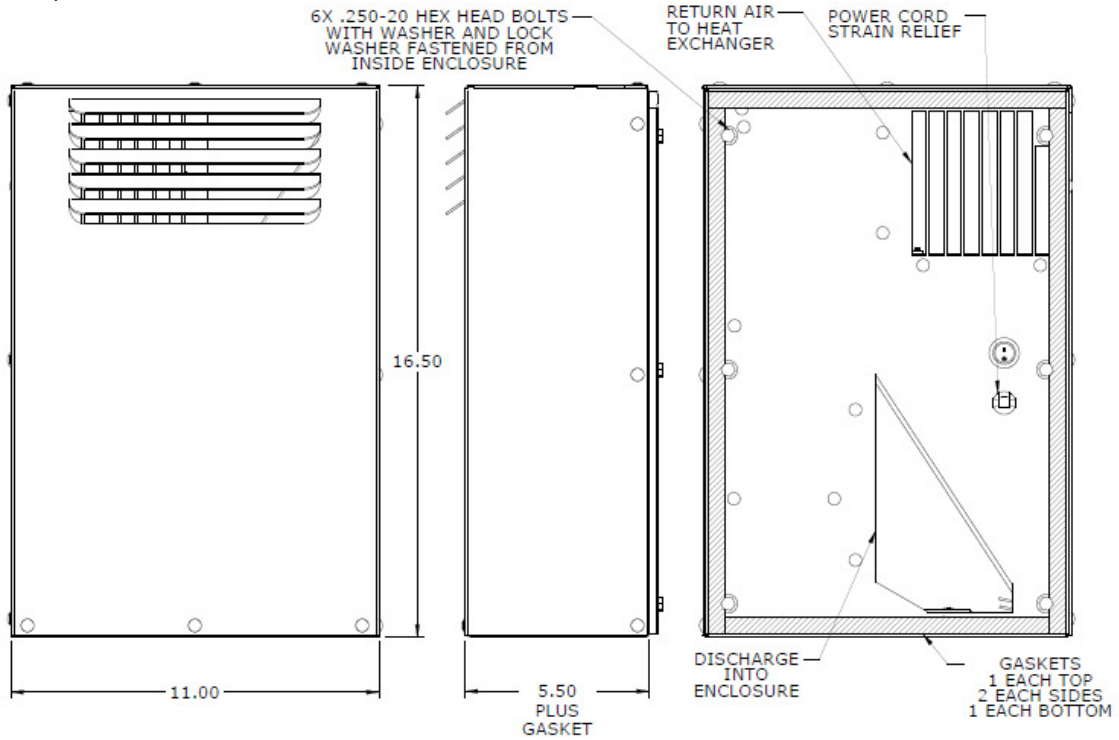

**Tall Series**

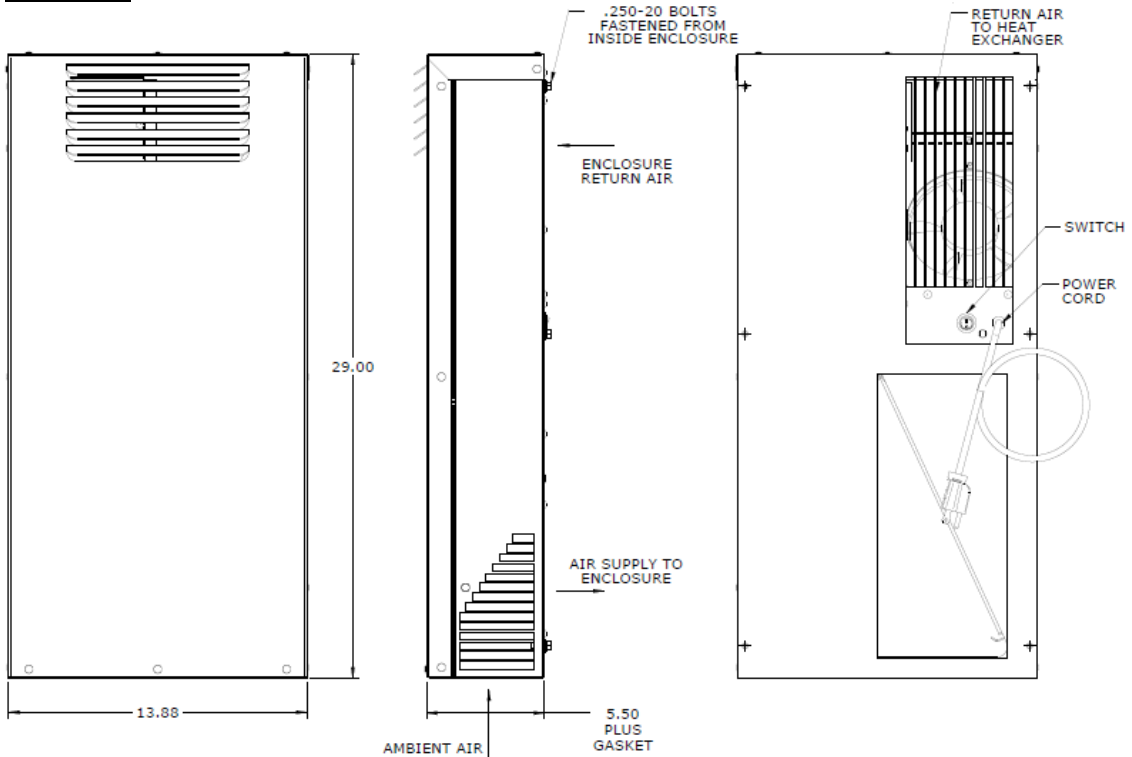

4421 Tradition Trail • Plano, Texas 75093 • 972-964-2700 • 800-836-7472

URL: [www.iscenclosurecooling.com](http://www.iscenclosurecooling.com) • Email: [iscinfo@iscsales.com](mailto:iscinfo@iscsales.com)



## Electrical Schematics

### System Schematic

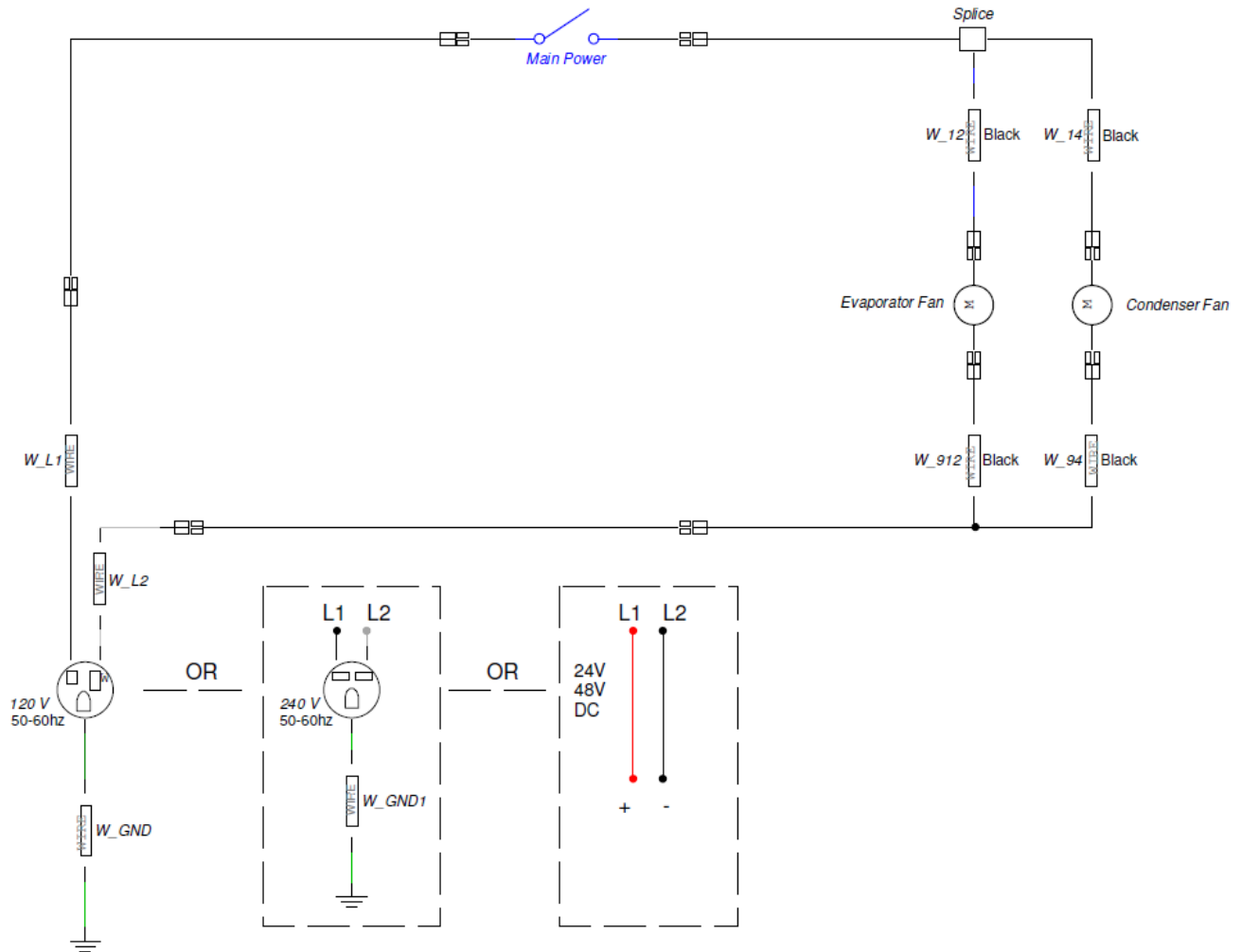

**Note:** Schematic applies to all voltages; DC voltages do not have ground wire.



## Warranty Information

ISC products are warranted to be free of defects in workmanship, materials and components. The warranty period applies from date of shipment for one year.

The above warranty applies when the equipment is operated under the following conditions:

- Ambient temperature not in excess of performance rating in normal atmosphere or as stated on product nameplate
- Voltage variation no greater than  $\pm 10\%$  from nameplate rating
- Frequency variation no greater than  $\pm 3\text{Hz}$  from nameplate rating
- Maximum cooling load no higher than heat exchanger nameplate rating
- Compliance to all other installation, maintenance and operating instructions, as supplied

ISC cannot assume responsibility for misapplication of its products or the erroneous selection of an inappropriate product by a non-authorized ISC representative. Our applications engineers will gladly assist in the selection of the proper product provided all required details of the application are furnished.

ISC assumes no liability beyond the repair or replacement of its own product. This Warranty does not cover:

- Labor or reimbursement of labor for evaluation, removal, installation, repair, or cost of any warranted part, except at the ISC factory in Dallas, Texas
- Use of equipment for other than its designed purpose or operating conditions
- Operation in harsh, oily, corrosive or other abnormal environmental conditions, without the proper filtration, sealing, protective coatings and/or weather protection
- Damage to system resulting from continuous operation with dirty or clogged air intake or improper or negligent maintenance
- Customer modification or abuse
- Shipping damage or other accident
- Repair or service by unauthorized personnel.

Cracked or broken hermetic tubing or brazed joints caused by shipping damage or mishandling are not covered under the Warranty. Claims for shipping damage are the responsibility of the Consignee. Timely claims must be filed with the freight carrier.

The purchaser assumes the responsibility of grounding the unit and installing it in accordance with local electrical and safety codes, as well as the 2008 National Electric Code (NEC) and OSHA.

**THIS WARRANTY CONSTITUTES THE ENTIRE WARRANTY WITH RESPECT TO THE PRODUCT AND IS IN LIEU OF ALL OTHERS, EXPRESSED OR IMPLIED, INCLUDING ANY WARRANTY OF MERCHANTABILITY AND WARRANTY OF FITNESS FOR A PARTICULAR PURPOSE AND IN NO EVENT IS ISC RESPONSIBLE FOR ANY CONSEQUENTIAL DAMAGES OF ANY NATURE WHATSOEVER.**

4421 Tradition Trail • Plano, Texas 75093 • 972-964-2700 • 800-836-7472

URL: [www.iscenclosurecooling.com](http://www.iscenclosurecooling.com) • Email: [iscinfo@iscsales.com](mailto:iscinfo@iscsales.com)



## Return Material Authorization (RMA) Procedure

All returns require a Return Material Authorization (RMA) number for warranty or non-warranty repair, rotation of stock, damage or any other reason.



### **IMPORTANT**

Returns without an RMA number will be refused and returned. Improper packaging may void warranty. Collect shipments will be refused.

Please be ready to provide:

- Purchase Order Number & Date
- Product Description & Reason for Request
- Model Number & Serial Number
- Customer name and contact info (email, phone number and address)
- Shipping method

Pack unit in suitable packing for shipment, preferably the original packaging if available.

- If suitable packing is not available, arrange for packaging to be shipped to you.
- Air Conditioners must be returned in an upright position properly secured to a pallet.
- Tip unit to empty water from the evaporator and boil off pans.
- Clearly mark the RMA number on the box.
- Customer will pay all freight charges.

### Out of Warranty Repair

If your ISC Air to Air Heat Exchanger is out of warranty and requires repair, simply call ISC Customer Service at (800)-836-7472 for an RMA number. Customer Service will help you determine what repairs or parts are needed and, if possible, an estimate of the cost.

After the unit is received and diagnosed, you will receive a cost estimate on the work and parts needed. The repairs and test process may uncover other issues of which you will be informed and given quotes for the work needed.



4421 Tradition Trail • Plano, Texas 75093 • 972-964-2700 • 800-836-7472

URL: [www.iscenclosurecooling.com](http://www.iscenclosurecooling.com) • Email: [iscinfo@iscsales.com](mailto:iscinfo@iscsales.com)